

WATTS®

INSTANT HOT WATER RECIRCULATING SYSTEM

INSTALLATION AND OPERATING INSTRUCTIONS



Save manual for future reference

<p>Pump and Comfort Valve CS VW MH26400 65GM</p> <p>CLASSIFIED UL</p> <p>WATER QUALITY ANSI/NSF 61</p> <p>DRINKING WATER SYSTEM COMPONENTS MAXIMUM USE TEMPERATURE: 140°F Mfg. by Grundfos Pumps</p>	<p>12" Supply Line and Adapters</p> <p>ANSI/NSF STD. 61 LISTED</p> <p>WATTS®</p>
--	---

Warning

Please read carefully before proceeding with installation. Your failure to follow any attached instructions or operating parameters may lead to the product's failure and possible damage to property. Refer to enclosed warranty for operating parameters to ensure proper use with your water supply.

Thank you for your purchase. You are now the owner of a WATTS HOT WATER RECIRCULATION System. It has been carefully inspected and tested before shipment. It should give you long, efficient, trouble-free service. For maximum performance and reliability, please follow the simple instructions in this manual.

NOTE: Please understand this is not an anti-scald device. You may have some warm water in your cold water line under the sink where the valve is installed. Once the cold water line is opened, the warm water will dissipate in a very short time.

Table of Contents

Package Contents	2
Operational Parameters.....	2
Pump Installation	3
Sensor Valve Installation	4
Sensor Valve Operation	5
Electrical	5
Timer Control Technical Data	6
Timer Operation	6
Warranty	7

Package Contents

Examine the components carefully to make sure no damage has occurred to the pump. Care should be taken to ensure the pump is NOT dropped or mishandled; dropping will damage the pump.

Package Contains the following:

- 1 - Hot water recirculator pump with timer
- 1 - Sensor Valve
- 2 - Valve mounting screws
- 2 - 3/8" compression to 1/2" threaded flex hoses
- 2 - Adapters
- 2 - Rubber washers
- Installation and Operating Instructions

Operational Parameters

The maximum allowable water temperature is 150 degrees F for the circulator pump and timer.

PUMP INSTALLATION

Water Heater Checklist



Electric Water Heater

Turn off Power to your Water Heater.
(turn off power at breaker box)



Gas Water Heater

Turn off the Gas to your water heater and
insure that the pilot light is not burning.

Pump Mounting: For Indoor Use Only

1. Close the supply water valve to the water heater located, in most cases, above the water heater on the cold water inlet to the hot water heater.

2. Drain the water from the hot water pipe by opening a hot water faucet in the house. Let the water run until it stops flowing. Then drain remaining water from hot water heater spigot. Leave the faucet in the house open until pump installation is complete. If water does not stop flowing, check to make sure the water to the hot water heater has been completely shut off.

3. Disconnect the hot water heater at the hot water discharge. (see Picture #1)

4. Install pump onto the water heater discharge, using the 3/4" female fitting. The pump should be installed so that the pump is pumping away from the hot water heater, towards the house. Confirm the direction of pumping by observing the flow arrow on the side of the pump housing (See Picture #2). Be sure that the pump is not touching the exhaust vent piping (chimney) of a gas or oil fired hot water heater.

5. Connect the hot water line to the 3/4" NPT discharge of the pump. Use pipe dope or Teflon tape to seal threads when connecting to a 3/4 female NPT connection. If a gasketed flexible copper water heater connector is used, pipe dope or Teflon tape is not required.

6. Reopen the supply valve to the hot water heater and allow the water to run until all the air has been purged from the piping.

7. Close faucet inside the house.

8. Plug the line cord of pump into a 115V outlet. Be sure to route the power cord so that it does not touch the exhaust vent piping of a gas or oil fired hot water heater.

9. Using the timer (see pg. 6), set the pump to operate around your peak use times. (ie. 30 minutes before the first shower until 15 minutes after last shower).

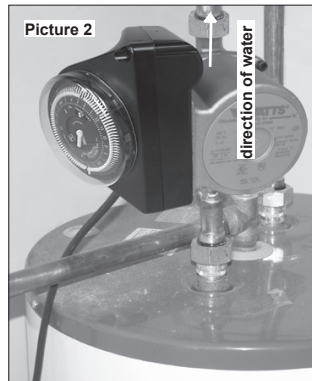
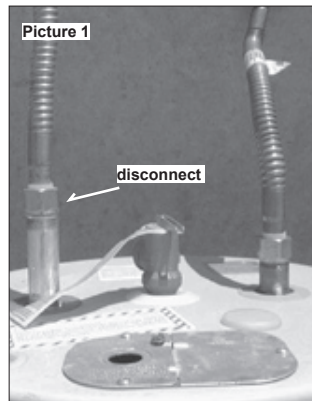
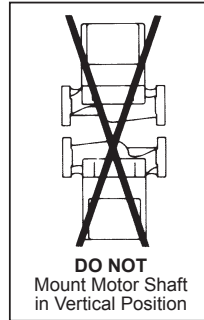

Sensor Valve Installation

Sensor Valve Location

For the greatest effect, the valve should be located at a faucet with the greatest piping distance from the hot water heater. If your home has a branched hot water line, more than one Sensor Valve may be necessary. Additional Sensor Valve kits can be found at some retail locations as well as the WATTS website at www.watts.com or by calling toll free at (800) 752-5582.

NOTE: Do not use Teflon tape or pipe dope on the Sensor Valve threads.

3/8" Stop Valve Installation

1. Close both the hot and cold stop valves below the sink (see Picture 3).
2. Place supplied rubber washers in female end of adapters. Attach adapters to both "Cold Water Out" and "Hot Water Out" ports of Sensor Valve. **Finger tight plus a quarter turn with wrench.**
3. Disconnect existing supply line connection from both hot and cold stop valves and then connect to adapter, attach to Sensor Valve (see Picture 4).
4. Connect the new 1/2" x 3/8" flex hose to the hot water stop valve (3/8" side) and the "Hot Water In" port (1/2" side) of the Sensor Valve (see Picture 5 & 6). Connect the remaining 1/2" x 3/8" flex hose to the cold water stop valve.
5. Open both the hot water and cold water stop valves.
6. If desired, Sensor Valve can be mounted to the wall with the mounting screws (see Figure 1).

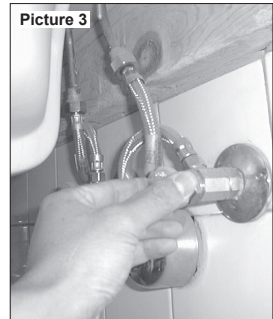

1/2" or Other Stop Valve Installation

1. Close both the hot and cold stop valves below the sink (see Picture 3).
2. Place supplied rubber washers in female end of adapters. Attach adapters to both "Cold Water Out" and "Hot Water Out" ports of Sensor Valve. **Finger tight plus a quarter turn with wrench.**
3. Disconnect existing supply line connection from faucet connection leave stop valve connection in place. Take disconnected end and attach to "Hot Water In" and "Cold Water In" connections respectively
4. Connect the new 1/2" x 3/8" flex hose to the already installed adapter (on Sensor Valve) (3/8" side) and the faucet connection (1/2" side) for both Hot Water and Cold Water respectively (see Picture 5 & 6).
5. Open both the hot water and cold water stop valves.
6. If desired, Sensor Valve can be mounted to the wall with the mounting screws (see Figure 1).

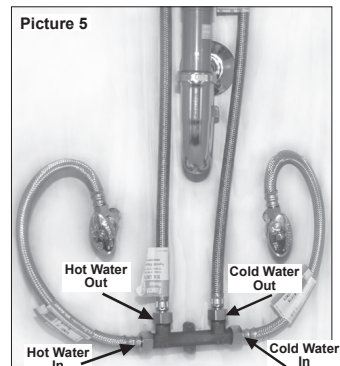

SENSOR VALVE OPERATION

If there is no hot water at the faucet or there appears to be too much hot water on the cold water side the following steps will determine if the valve is operating correctly:

1. Close the cold water stop valve below the sink.
2. Open the cold water faucet.
3. Water should slowly flow from the faucet until hot water reaches the valve. The flow should gradually decrease until no water is coming from the faucet at which time the valve is closed.

ELECTRICAL

SAFETY WARNING



WARNING - Risk of electrical shock - This pump is supplied with a grounding conductor. To reduce the risk of electric shock, be certain that it is connected only to a properly grounded grounding type receptacle. The safe operation of this pump requires that it be grounded in accordance with the National Electrical Code and local governing codes and regulations.

Electrical Requirements

The operating voltage and other electrical data are marked on the motor label. Make sure that the motor is suitable for the electrical supply on which it will be used.

Electrical Connection

Insert the 115V plug on the line cord from the pump into a properly grounded 115V outlet.

TIMER CONTROL TECHNICAL DATA

Supply Voltage:	120 VAC, 60Hz
Shortest Switching Interval:	15 minute increment
Switch Modes:	"Timer", "ON" Override, "OFF" Override
Protection:	Clear plastic cover for dust and moisture protection of the clock face.

Timer Technical Application

The timer control is designed only for use with the specified WATTS INSTANT HOT WATER RECIRCULATING SYSTEM. Installed indoors on hot water service systems.

The timer control is designed to turn the circulator on and off at preset times, allowing the user to select operation of the circulator during high use periods of the day.

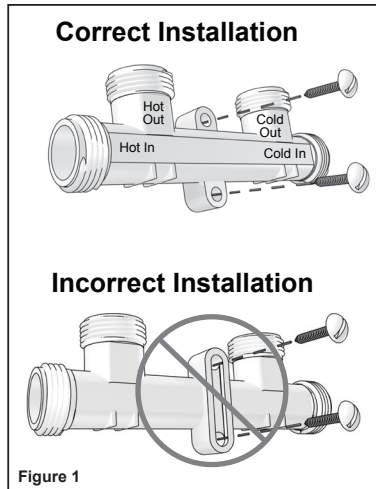

TIMER OPERATION



NOTE: Before the circulator is started, the water system must be filled with water and vented.

The timer has three modes of operation controlled by a manual switch:

- 1) **OFF** position: No pumping - circulator off
The timer will still keep time of day
- 2) **TIMER** position: Circulator controlled by programming tab settings "ON or OFF"
- 3) **ON** position: Circulator in continuous pumping mode
24-hours/day 7-days a week

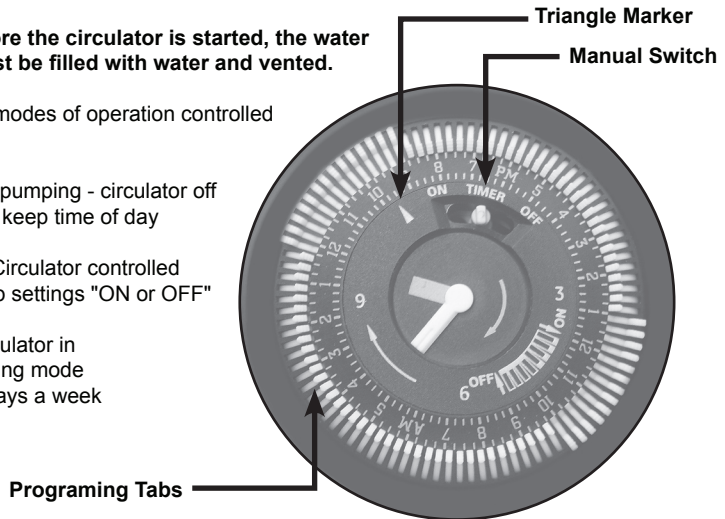

Time Setting

NOTE: DO NOT SET THE TIME BY ROTATING "OUTER" DIAL. TO SET THE CURRENT TIME, TURN THE MINUTE HAND CLOCKWISE.

Turn the minute hand clockwise until time of day on the outer dial is aligned with the triangle marker on the inner dial.

Example for 10:30 AM. Turn the minute hand clockwise until 10:30 AM is aligned with the triangle on the inner dial. The hour and the minute dial will show exactly 10:30.

Programming

24-Hour (Timer manual switch position)

The 24-Hour dial has quarter-hour division tabs plus AM/PM indications. Set the required "ON/OFF" times on the programming ring by pushing the tabs away from or towards the center of the ring. Tabs pushed away from the center ring indicate circulator "ON" while tabs pushed towards the center ring indicate circulator is switched "OFF".

The circulator will now start/stop according to the settings of the programming tabs.

In case of power outage the timer will not keep time. Repeat time setting step when power is restored.



Limited Warranty



What your Warranty Covers:

If any part of your WATTS INSTANT HOT WATER RECIRCULATING SYSTEM is defective in workmanship, return unit after obtaining a return authorization (see below), within 12 months from original retail purchase. WATTS will repair or, at WATTS option, replace the unit.

How to obtain Warranty Service:

For warranty service, call 1-800-752-5582 for a return authorization number. Then, ship your unit to our factory, freight and insurance prepaid, with proof of date of original purchase. Please include a note stating the problem. WATTS will repair it, or replace it, and ship it back to you prepaid.

What this warranty does not cover:

This warranty does not cover defects resulting from improper installation, (contrary to WATTS printed instructions), from abuse, misuse, misapplication, improper maintenance, neglect, alteration, accidents, casualties, fire, flood, freezing, environmental factors, water pressure spikes or other such acts of God.

This warranty will be void if defects occur due to failure to observe the following conditions:

1. The WATTS INSTANT HOT WATER RECIRCULATING SYSTEM Water System must be hooked up to a potable municipal or well water supply.

This warranty does not cover any equipment that is relocated from the site of its original installation.

This warranty does not cover any equipment that is installed or used outside the United States of America and Canada.

LIMITATIONS AND EXCLUSIONS:

WATTS WILL NOT BE RESPONSIBLE FOR ANY IMPLIED WARRANTIES, INCLUDING THOSE OF MERCHANTABILITY AND FITNESS FOR A PARTICULAR PURPOSE. WATTS WILL NOT BE RESPONSIBLE FOR ANY INCIDENTAL OR CONSEQUENTIAL DAMAGES, INCLUDING TRAVEL EXPENSE, TELEPHONE CHARGES, LOSS OF REVENUE, LOSS OF TIME, INCONVENIENCE, LOSS OF USE OF THE EQUIPMENT, AND DAMAGE CAUSED BY THIS EQUIPMENT AND ITS FAILURE TO FUNCTION PROPERLY. THIS WARRANTY SETS FORTH ALL OF WATTS RESPONSIBILITIES REGARDING THIS EQUIPMENT.

YOUR RIGHTS UNDER STATE LAW:

Some states do not allow limitations on how long an implied warranty lasts, and some states do not allow the exclusion or limitation of incidental or consequential damages, so the above limitations or exclusions may not apply. This warranty gives you specific legal rights, and you may have other legal rights which vary from state to state.

CALIFORNIA PROPOSITION 65 WARNING

WARNING: This product contains chemicals known to the State of California to cause cancer and birth defects or other reproductive harm. (California law requires this warning to be given to customers in the State of California.) For more information: www.wattsind.com/prop65



LUPTLW04 01/09
PRINTED IN USA

Phone: 800-752-5582

www.watts.com

Fax: 623-931-0191